

VERY NARROW AISLE SOLUTIONS

RAYMOND





BUILT TO PERFORM. DESIGNED TO WORK TOGETHER.

For 90+ years, Raymond® has built a reputation based on top-notch quality, reliability and exceptional customer service.

We design and build the best lift trucks in the business. We provide technologies, systems and solutions that bring day-to-day warehouse and distribution operations to a new level of performance. And we support customers with a network of skilled service centers and technicians unmatched in the industry.

From our eco-efficient trucks and telematics to our warehouse optimization and flexible financing, Raymond's big-picture approach and precisely targeted solutions are designed to adapt and grow with your business.

Our innovations in energy savings, space utilization, ergonomics, manufacturing quality and fleet optimization – combined with our best-in-class products and services – work together to increase efficiency and lower costs throughout your material handling operations.

Raymond stands ready to help you run better and manage smarter – end to end.



WATCH YOUR SPACE MULTIPLY

The proliferation of warehouses applying very narrow aisle designs would not have happened without the vision and innovation of Raymond engineers. We pioneered the narrow aisle concept with the introduction of the Raymond® Reach-Fork truck in 1954. And with the introduction of the Raymond® Swing-Reach truck in 1974, we set yet another standard for very narrow aisle trucks.

Today, there are more Raymond Swing-Reach® trucks in operation in North America than all competitors combined. Our trucks have logged more than 100 million hours of operation, and moved more than 1.2 billion loads.

The Raymond family of very narrow aisle trucks — including our newest addition, the 9800 Swing-Reach® truck — represents 40 years of continuous innovation. Collectively, the Swing-Reach product family provides a depth of capabilities that is unequaled, a fact that is proven every day in the widest range of applications in the warehouse industry. Our trucks are engineered to maximize our customers' needs to go higher and narrower, and expand warehouse capacity up to 300%.

Our Swing-Reach trucks do more than lift products, they lift businesses to greater heights of productivity and profitability.

A VERY WIDE RANGE OF SOLUTIONS
FOR OPERATING IN VERY NARROW AISLES

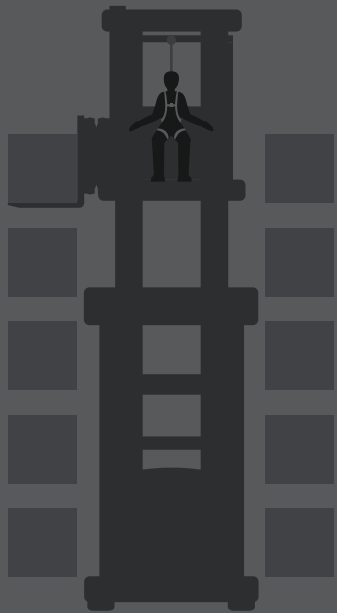

9600 SWING-REACH®
CAPACITIES UP TO 3,000 LBS
LIFT HEIGHTS UP TO 33 FT.
AISLE WIDTHS OF 5 FT. 4" - 6 FT. 4"



9700 SWING-REACH®
CAPACITIES UP TO 3,000 LBS
LIFT HEIGHTS UP TO 43 FT.
AISLE WIDTHS OF 5 FT. 4" - 6 FT. 4"



9800 SWING-REACH®
CAPACITIES UP TO 3,300 LBS
LIFT HEIGHTS UP TO 50 FT.
AISLE WIDTHS OF 5 FT. 10" - 6 FT. 8"

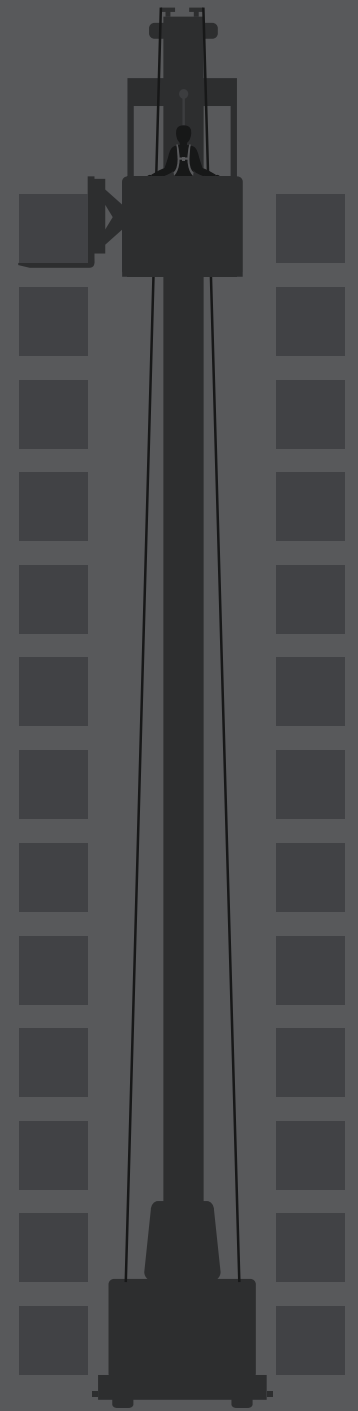

TRANSTACKER®
CAPACITIES UP TO 4,000 LBS
LIFT HEIGHTS UP TO 58 FT.
AISLE WIDTHS OF 4 FT. 10" - 5 FT. 6"

**not to scale*

HOW MANY MORE
PALLETs COULD YOU
STORE WITH A 42-FOOT
TOP LOAD BEAM?

9600 AND 9700 SWING-REACH[®] TRUCKS

SETTING THE STANDARD FOR VERY NARROW AISLE VERSATILITY

Engineered to maximize usable warehouse space, the Raymond[®] 9600 and 9700 Swing-Reach trucks can potentially triple pallet capacity within the existing warehouse footprint and provide significant cost savings. They are ideal for applications that call for full pallet handling and case picking.

The 9600 and 9700 Swing-Reach trucks provide lift heights up to 43 feet and capacities up to 3,000 pounds. They can operate in aisles as narrow as 66 inches with standard loads and 13-foot intersecting aisles with loads up to 52 inches wide.

The 9600 and 9700 Swing-Reach trucks were engineered and designed with a holistic approach of understanding space constraints and narrow aisle applications.

+ open view, twin tubular mast
*provides unmatched visibility and stability
in either travel direction*

+ auxiliary mast
*can be raised to the most
ergonomically advantageous height*

+ three-wheel design
*provides stability and operator
confidence at height*

+ reach-fork pantograph design
and standard 4"x1.75" forks
*allows for long side handling of
double-sided pallets*



+ three driving positions —
seated, standing and leaning
*provide operator comfort throughout
the shift*

+ spacious operator compartment
*achieved by placing the operator
between the mast uprights*

+ control arms and sidegates
*can be raised to create a generous
picking window*

+ swivel seat
*provides excellent visibility through the
open view mast when traveling in the
tractor first direction*

+ low 16" step height
*easier entry into
operator compartment*

PUTTING PRODUCTIVITY FIRST

Every Raymond Swing-Reach truck is a customized solution that is engineered to move loads more quickly and efficiently, and enable operators to work smarter, not harder. Smooth hydraulic controls provide precise load handling for less product damage and greater maneuverability in very narrow aisles. Fine positioning and control of lift, travel and load handling improves control of loads, which results in greater operator efficiency. In addition, the ergonomically designed wrap-around operator compartment eliminates discomfort that can adversely affect productivity.

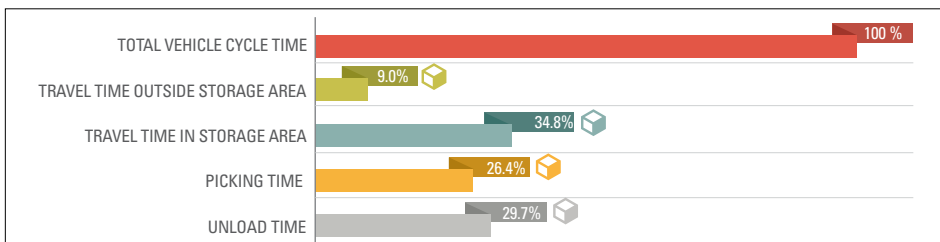

ACR SYSTEM™

Provides quicker acceleration and electronic braking, faster lift and lower speeds, and smoother direction changes for more efficient load handling and movement in storage aisles. 📦

INTELLISPEED™

Optimizes travel speed at height. Provides smooth coordination between travel speeds based on load height and weight. 📦



PICKING/LOAD HANDLING

Precise load handling and fine positioning with smoother auxiliary and mast performance and simultaneous function controls. 📦📦



INTELLIGUIDE™

Wire guidance eliminates the need for steering in the aisle. Quick wire engagement supports fast and secure aisle changes and eliminates product and rack damage. 📦

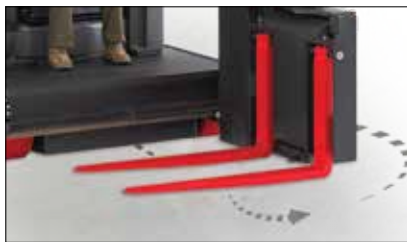

AUTO TRAVERSE AND ROTATE FUNCTIONS

Improve productivity and reduce product damage by automatically synchronizing traverse and rotate movements to keep forks within the aisle when repositioning them. 📦📦



OPEN VIEW MAST DESIGN

Offers the only unobstructed mast visibility in the industry. Twin tubular mast design provides optimum stability when traveling loaded and elevated. 📦

GET MORE WITH YOUR RAYMOND 9600 AND 9700 SWING-REACH TRUCKS



THREE DRIVING POSITIONS

Seated, standing and leaning positions offer operator comfort and flexibility throughout the day. Whether you are moving pallet loads or picking cases, you can choose the best position for the task.



VEHICLE NAVIGATION ASSISTANT

Operator interface displays load weight and position, truck height, wire guidance status and other important operational data.



INTUITIVE CONTROL HANDLES

Fully adjustable, single axis, simultaneous function control handles engineered to provide the control your operators need to excel.



ERGONOMICALLY DESIGNED OPERATOR COMPARTMENT

Features a seat that swivels for excellent visibility through the open view mast, and a LED light and fan package that comes standard.



REACH-FORK PANTOGRAPH CARRIAGE DESIGN

Allows the truck to operate in narrower aisles than competitor's offset fork designs. 4" x 1.75" forks allow for long side handling in applications that require case picking.

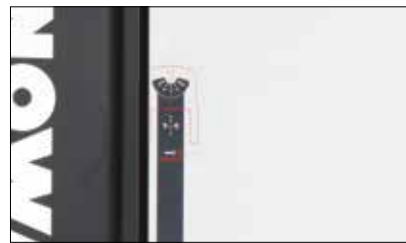

HEADS UP DISPLAY

Located on the mast guard for standing tractor first travel, helps to reduce product damage.



EASE OF MAINTENANCE

Convenient service access and fewer component parts to service and replace results in less downtime and lower cost of operation.

EFFICIENCY BY DESIGN

Reducing energy consumption is the underlying philosophy behind all Raymond products. Our adherence to sound engineering design principles, comprehensive testing and 40 years of Swing-Reach experience have resulted in trucks that provide rock-solid stability at height with less dead weight. In fact, third-party testing has shown that our Swing-Reach trucks are 40%* more energy efficient than competing models.

Our proven ACR System enables users to save energy, reduce battery changing and charging needs, increase overall uptime and lower maintenance costs.

* Results from the 2011 United States Auto Club Comparative Data Report.



OPTIONS:

Unique solutions for unique challenges

- Extended turret to accommodate loads up to 108" wide
- Multiple lift limit with bypass
- Cold storage conditioning with optional heated cab
- End of aisle slowdown
- iWAREHOUSE® Fleet and Warehouse Optimization System

FEATURES FOR EASY MAINTAINABILITY:

- Diagnostics on display
- Ease of component access
- Superb mast serviceability
- Side battery access with rollers
- Heavy-duty drive unit
- Fewer components to service
- Best-in-class components



REGENERATIVE LOWERING

Creates power by returning energy to the battery when the truck is lowering its load, resulting in fewer battery changes and reduced downtime.



LONGER BATTERY LIFE

Full shift performance in most applications with up to a 42% smaller battery than comparable competitor trucks.

9600 AND 9700 SWING-REACH



HOW MANY MORE PALLETS
COULD YOU STORE WITH A
49-FOOT TOP LOAD BEAM?

9800 SWING-REACH[®] TRUCK

TAKING YOUR WAREHOUSE TO
THE NEXT LEVEL

For the most demanding applications, the Raymond[®] 9800 Swing-Reach truck is the ultimate very narrow aisle truck. It offers a whole new level of productivity and energy efficiency, utilizes spaces more effectively and sets a new standard for driving down costs. The 9800 Swing-Reach truck has been developed with a number of unique features that are engineered to lift heavy loads higher in a highly compact footprint, and to improve speed and efficiency in operations. This truck is suited for most existing very narrow aisle operations, including freezer applications, and has the capacity to lift 3,300 pounds to 30 feet, and 2,500 pounds to nearly 50 feet with only a 60-inch overall width.

+ clear view triplex mast

a triplex mast with low collapsed heights and no cables or hoses to clutter it up, provides excellent visibility in every direction

+ advanced belt drive

provides smooth operations and fast fork traverse

+ integrated control panel

color display with important operational data

+ articulated steering

navigates between aisles in less than 10 seconds using a transfer aisle up to three feet narrower than non-articulated trucks

+ advanced lifting system

utilizes a third cylinder to displace the dead weight of the mast and operator compartment, reducing energy demands

+ contoured flip-up seat

flip-up mechanism allows for driving in the standing position

+ flip-up sidegates

feather light gates that are simple to operate

+ dual drive, four-wheel design

provides ultimate stability for class-leading lift capacities, reduced floor loading and a smoother ride



A NIMBLE GIANT

The Raymond 9800 Swing-Reach truck isn't just a space saver. It's a hard-working space user. The durable, unique articulated steering system enables the truck to maneuver easily through 13-foot intersecting aisles with a 50-inch load. It's also easy to drive in 'free-ranging' conditions when outside of the storage aisle. As a result, operators spend less time maneuvering and more time working. With superb acceleration, electronic braking and intellispeed™, travel speeds are optimized both at height and in the aisle.



DUAL DRIVE, FOUR-WHEEL DESIGN

Provides stability, class-leading lift capacities and reduced floor loading.



ADVANCED BELT DRIVE

Offers the benefits of smoother and faster fork traverse that automatically adapts to load weight.



MASSIVE AND RIGID TRIPLEX MAST

Provides ultimate stability and operator confidence at height.



VERTICAL HOLD (OPTIONAL)

Optional height pre-selector lifts the forks or platform to pre-programmed levels. Controlled with a soft key on the integrated control panel, the pre-selector simplifies lifting the truck to the correct pallet location.

MORE SPACE BY DESIGN

The articulated steering system allows for a narrower aisle and additional pallet positions on storage aisle ends. This can result in up to four extra pallet positions provided on each level within an aisle. And with lift heights to nearly 50 feet, the 9800 Swing-Reach truck can provide up to 60 extra pallet positions per aisle.

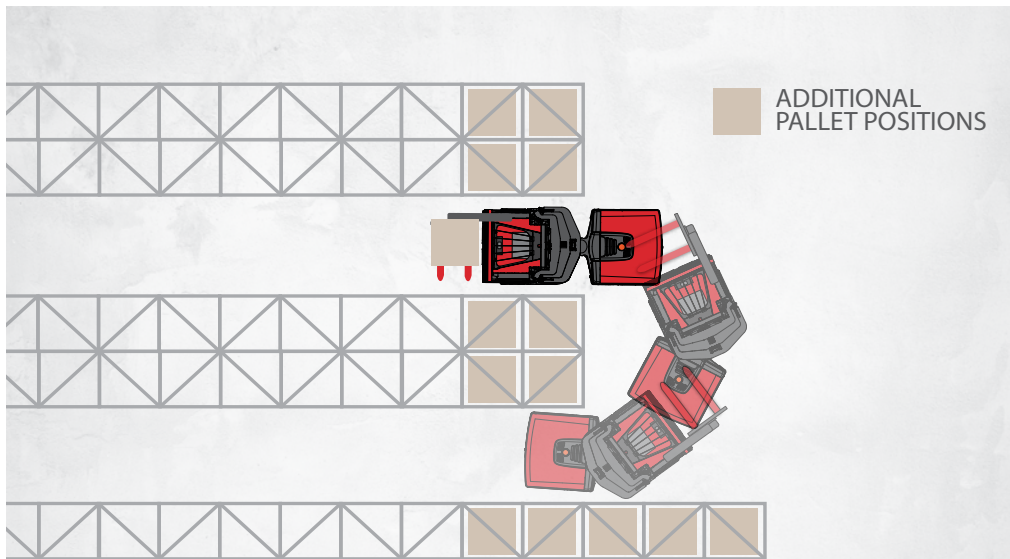

2,500 LBS

NEARLY 50 FT.

60" OVERALL WIDTH

9800 SWING-REACH



GET MORE WITH YOUR RAYMOND 9800 SWING-REACH TRUCK



CLEAR VIEW TRIPLEX MAST

Provides excellent visibility in both travel directions.



iNTELLIGUIDE™

Wire-guidance eliminates the need for steering in aisles, reducing product, truck and facility damage.

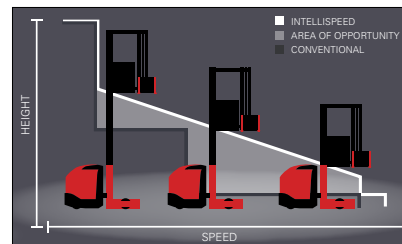

iNTELLISPEED

Optimizes travel speed at height. Provides smooth coordination between travel speeds based on load height and weight.

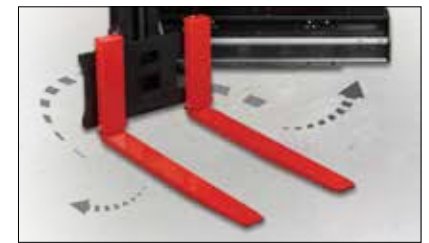

AUTO TRAVERSE AND ROTATE FUNCTIONS

Improve productivity by automatically synchronizing traverse and rotate movements to keep forks within the aisle when repositioning them.



INTEGRATED CONTROL PANEL

Fully adjustable panel that has intuitive simultaneous function controls.



ERGONOMICALLY DESIGNED OPERATOR COMPARTMENT

Features a plush operator seat with a flip up mechanism for driving in the standing position.



VEHICLE NAVIGATION ASSISTANT

Color display with load weight and position, truck height, wire guidance status and other important operational data.



EASE OF MAINTENANCE

Convenient service access and fewer component parts to service and replace results in less downtime and lower cost of operation.

MAXIMUM ENERGY EFFICIENCY

The Raymond 9800 Swing-Reach truck is designed with energy-saving features that increase efficiency and drive down costs. A simple and efficient 48-volt system provides main lift speeds up to 88 feet per minute compared to competitor 72- and 80-volt systems; allows for a smaller lift motor, which reduces heat loss; and enables users to run as long as two shifts on one battery charge in many applications.



ADVANCED LIFTING SYSTEM

Fully integrated combination of hydraulic and gas-pressure lifting for smooth operation results in 40% less energy used than many competing models.



REGENERATIVE LOWERING

Creates power by returning energy to the battery when the truck is lowering its load, resulting in fewer battery changes and reduced downtime.

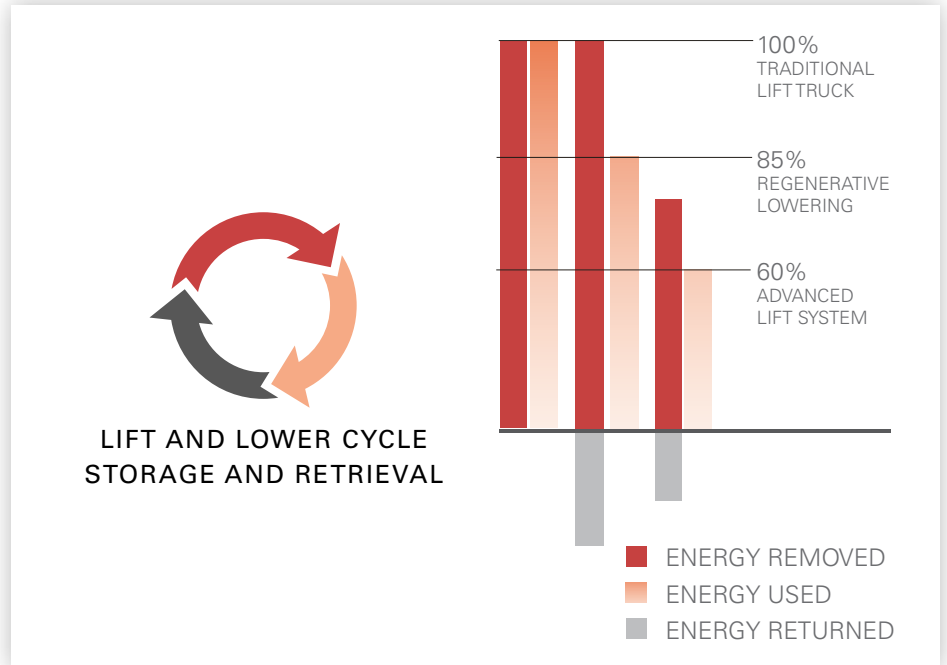



OPTIONS:

Unique solutions for unique challenges

- Programmable traverse stops for handling multiple load lengths
- Extended turret to accommodate loads up to 110" wide
- Multiple lift limit with bypass
- Cold storage conditioning with optional heated cab
- End of aisle slowdown
- iWAREHOUSE® Fleet and Warehouse Optimization System

FEATURES FOR EASY MAINTAINABILITY:

- Diagnostics on display
- Ease of component access
- Superb mast serviceability
- Side battery access with rollers
- Heavy-duty drive units
- Fewer components to service
- Best-in-class components

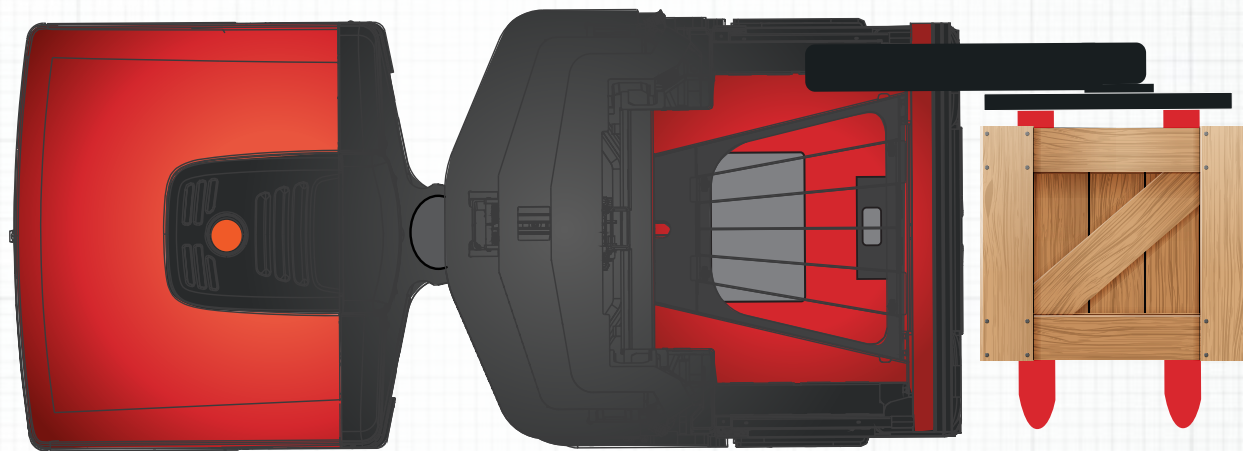

ADVANCED LIFTING SYSTEM

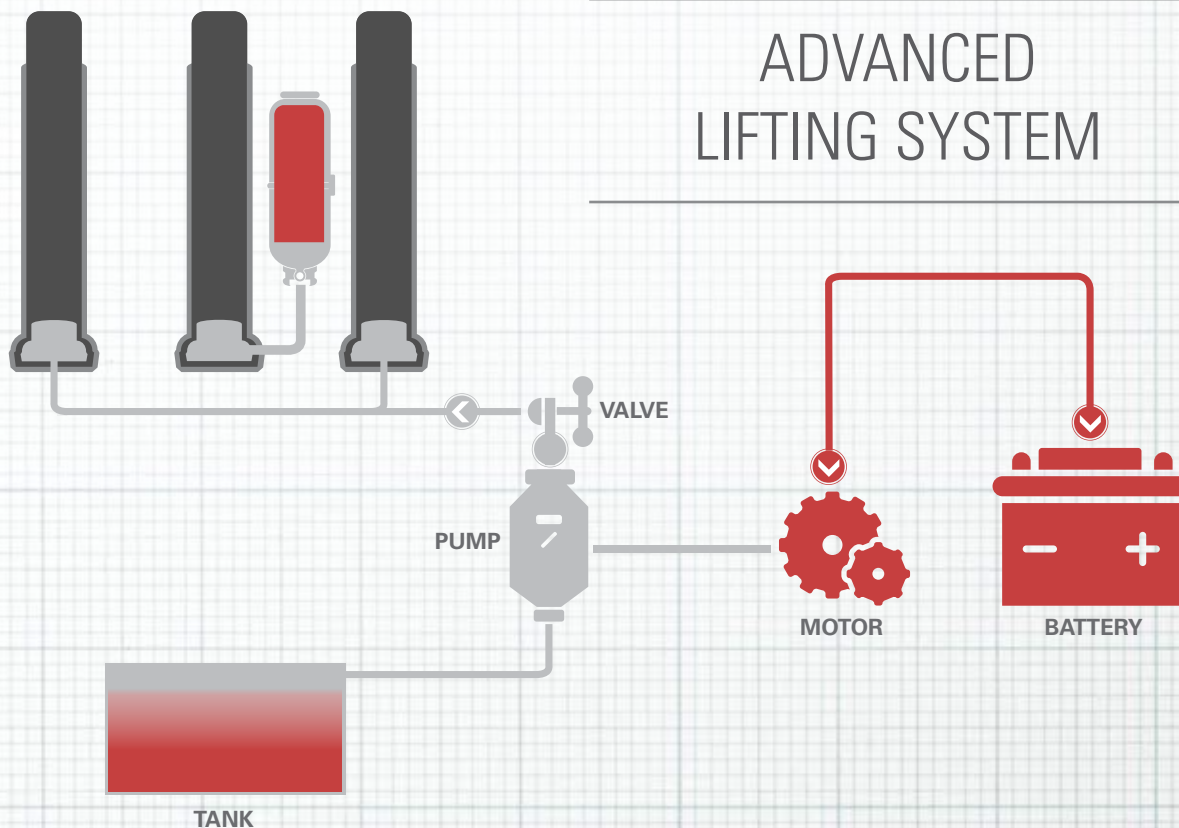

HOW MANY MORE
PALLETES COULD YOU
STORE WITH A
58-FOOT TOP LOAD BEAM?

TRANSTACKER®

ULTIMATE STORAGE DENSITY

This dual-purpose, heavy duty, AC/DC-powered machine combines case picking with unit load handling in a single truck, making it ideal for high density applications with a need for maximum selectivity. With its capacity of up to 4,000 pounds, elevated height of 59 feet, and the ability to operate in aisles as narrow as 54 inches, the Transtacker truck sets the standard for high performance and versatility.

+ flexible fit

good fit for both new construction or existing stacker crane storage areas

+ dynamic hoist braking

slows hoist motion to smooth stop prior to engaging mechanical brake, minimizing wear and maximizing operator comfort

+ rotating reach fork handler

allows use of post and beam pallet rack for installation

+ ultimate capacity

capable of lifting 4,000 pounds to any height with no speed reductions

+ unmatched stability at height

top- and bottom-mounted guide rails, full-height mast and cantilever operator compartment

+ automatic steer lock with indicators

electrically locks steering position while in the aisle, preventing damage

+ easy aisle changes

flexible Storage and Retrieval Truck (SRT) option results in lower capital costs compared to fixed stacker cranes

+ intuitive operator controls

allows control of critical truck functions with maximum efficiency and comfort

+ ergonomically designed operator compartment

operator comfort for greater productivity through the shift



BECAUSE YOU CAN'T SLOW DOWN

The Raymond Transtacker truck is a rugged, reliable and versatile workhorse designed for multi-shift, high throughput applications. With a combined AC/DC power package, a 24/7/365 operating environment is possible with no downtime for battery changing or charging. Power combined with smoothness and stability creates a vehicle that increases operator confidence, efficiency and productivity.

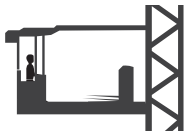

OPERATOR-UP DESIGN

Ideal for unit load storage and retrieval – with minimal product damage, orderpicking and inventory verification.



SRT ELECTRIC LIFT DESIGN

Means no hydraulic components and longer service life. It's like getting two trucks in one.



ADVANCED PLC CONTROLS

Provide fine positioning and control of lift, travel and load-handling functions for enhanced operator confidence and productivity.



TRANSISTORIZED SPEED CONTROL

Provides smooth, variable control with a top speed of 5.5 mph in the storage aisle and 2.5 mph outside of the aisle.



NO SPEED REDUCTIONS

Can lift 4,000 pounds to any height with no speed reductions.



PALLET CENTERING DEVICE

Aligns pallet in proper position and centers load on forks to maintain constant travel clearance. *(Fork load handler only)*

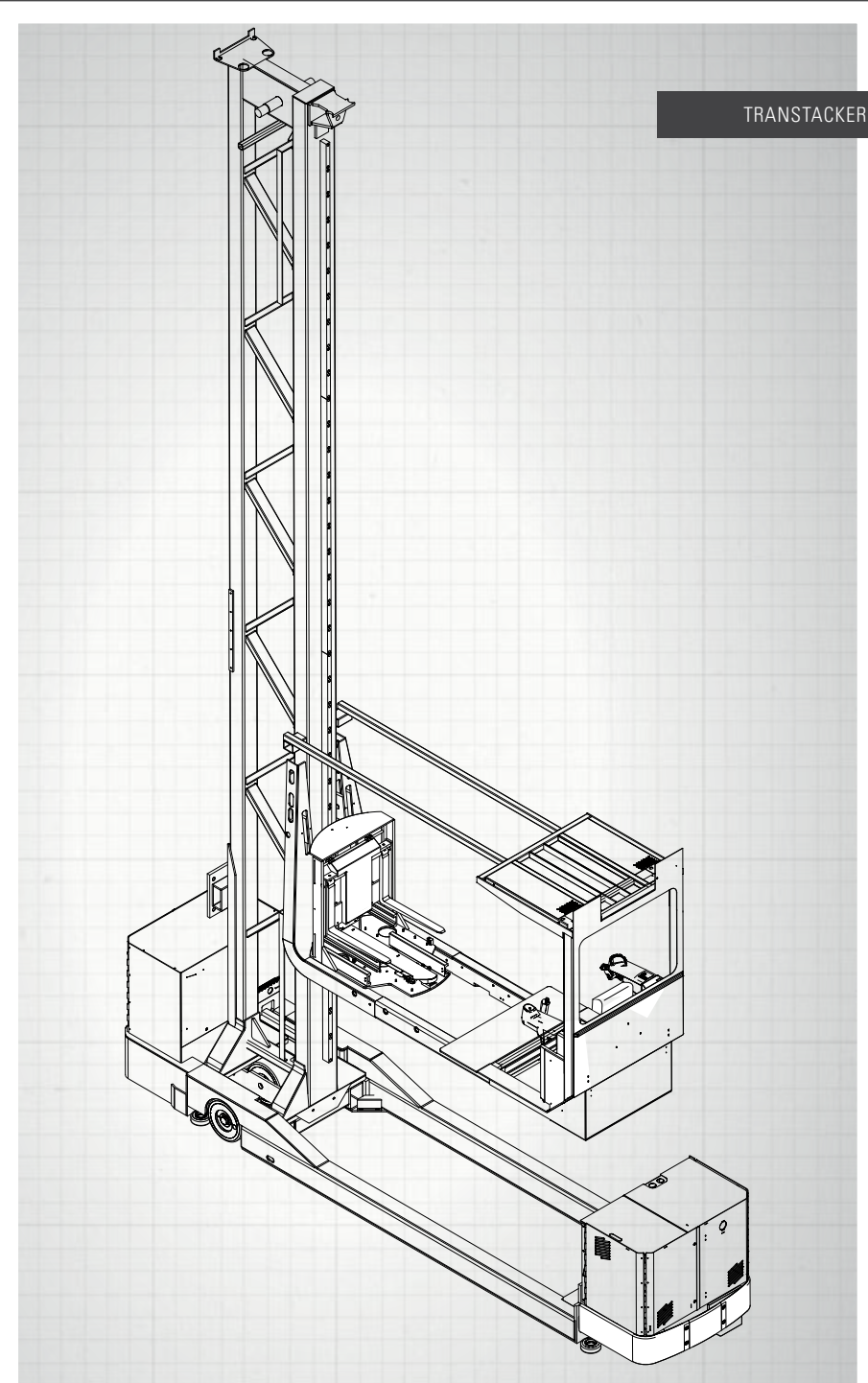

GET MORE WITH YOUR RAYMOND TRANSTACKER TRUCK



UNIQUE WHEEL ARRANGEMENT

Center wheels work in the aisle for most support while outside wheels provide support when changing aisles. Provides optimum wheel loading while in the working aisle.



ADJUSTABLE ARMRESTS AND CONTROLS

Allows for convenient operation from seated and standing positions.



ERGONOMICALLY DESIGNED OPERATOR COMPARTMENT

Assures operator comfort for greater productivity throughout the shift.



INTUITIVE OPERATOR CONTROLS

Allows operator control of critical truck functions with maximum efficiency and comfort.



TRANSTACKER



ROTATING REACH-FORK LOAD HANDLER

Allows use of post and beam pallet rack for installation, which is less expensive than high rise rack.



DYNAMIC HOIST BRAKING

Slows hoist motion to a smooth stop prior to engaging mechanical brake, minimizing hoist brake wear and maximizing operator comfort.



AUTOMATIC STEER LOCK WITH INDICATORS

Electrically locks steering position while in the aisle, preventing damage to drive unit from incorrect alignment when in guided aisle.

PROVEN POWER PERFORMER

With the dual AC/DC power supply, the Raymond Transtacker truck is well-suited for 24/7 operations. Because the truck operates primarily on AC power, the operator's compartment can be enclosed and equipped with lighting and climate controls. This is ideal in applications that require climate control, such as cold storage or air conditioning, and where cleanliness is a concern since there are no hydraulics to cause leakage. This feature can also reduce or eliminate lighting, heating and air-conditioning costs in the storage area for additional efficiency and cost savings.



REGENERATIVE BRAKING

Provides electromotive braking reducing motor heat and extends motor brush life.

AC INSIDE THE STORAGE AISLE

While in the aisle, the Transtacker truck operates on AC power and is guided by floor and ceiling-mounted guide tracks.

DC OUTSIDE THE STORAGE AISLE

Outside the storage aisle, the Transtacker truck operates as a DC battery-powered vehicle. This provides fast and easy aisle-changing capabilities with no mechanical aisle-changing devices.

36V DC

DC power is supplied by a 36-volt industrial battery that is automatically recharged when the vehicle is operating in the storage aisle.



TRANSTACKER

OPTIONS:

Unique solutions for unique challenges

- Optional lighted, enclosed, climate controlled operator compartment
- Programmable performance parameters
- Custom options for multiple load handling

FEATURES FOR EASY MAINTAINABILITY:

- Diagnostics on display
- Automatic steer lock with indicators to ensure correct alignment and prevent damage to drive unit

WHETHER YOU'RE BUILDING OR BUILDING BIGGER.

We know what it takes to change, expand or build from the ground up.

We work closely with customers to develop and implement a complete material-handling solution to suit any situation—with the trucks, tools and technology to maximize the efficiency of your current space, adapt to a new facility, or build a new warehouse from scratch.

We start with a data-driven analysis of your existing or proposed facility. We help you determine the right trucks to right-size your fleet. And we develop a complete system design with Raymond Sales and Service engineering or by partnering with your staff or preferred vendors.





FROM FLEET TO FINANCE

In warehouse management, the bottom line is the bottom line. And because efficiency works best when it works end to end, everything Raymond offers is built to work together. Trucks and training. Space utilization and warehouse optimization. Fleet maintenance and responsive financing—designed to fit the way you work. To help you work better, smarter, more cost effectively. From a single source you know and trust.

From initial consultation to custom-designed solutions to long-term product and operational support, we offer an unmatched depth of services to get you from where you are to where you want to go.

END TO END



+ warranty coverage

Raymond Asset Protection™ is Raymond's industry-leading warranty that begins with a Standard Warranty – coverage that starts the moment the new truck arrives at your facility and continues for three years. It lets you select the coverage that fits your fleet so you can maximize performance while locking in affordable, predictable service costs.



+ maintenance

Designed to fit your budget, Raymond offers three plans specific to your needs which you can tailor for individual trucks or entire fleets: contract maintenance, comprehensive fixed-price maintenance and scheduled maintenance audit.



+ expert technicians

For those customers who have lift truck technicians on-site, Raymond offers Customer Technician Courses. Training is available at Raymond headquarters, at your facility or your local Raymond authorized Sales and Service Center.



+ parts

Raymond Parts™ is the industry's most comprehensive one-stop shop for world-class lift truck parts. Raymond is committed to meet all your parts and supply needs, regardless of the make or model of the truck. We sell only the highest quality parts that meet or exceed OEM quality standards.



+ financing

For an outstanding and flexible Raymond equipment solution, your Raymond Sales and Service Center and Raymond Leasing Corporation deliver what your business needs – the equipment you need to grow, at fixed costs. Raymond offers low ownership interest rates and variety of affordable and flexible lease options.



+ pre-owned lift trucks

Raymond RENEWED™ offers certified, pre-owned electric lift trucks that have undergone a rigorous quality inspection and reconditioned with genuine OEM parts from top to bottom. Every truck is delivered with full warranty coverage.



+ iTRACK®

iTRACK Fleet Asset Management System helps to reduce your overall cost of ownership by providing accurate, actionable fleet maintenance data and reports – from individual trucks to fleets or across your entire enterprise of lift trucks. iTRACK is your anytime, anywhere web-based asset management system that works for you 24/7/365.



+ rentals

A Raymond rental is the smart and economical solution to meet your interim material handling needs – whether you are looking for seasonal rentals, unplanned peaks in activity, replacing trucks for scheduled repairs or waiting for delivery of new equipment. Or, if you just want to establish the value of the equipment before purchasing or leasing.



+ iWAREHOUSE®

Designed with an intuitive interface and information display, iWAREHOUSE Fleet and Warehouse Optimization System enables you to take 360 degree control of truck and operator efficiencies through a suite of electronic diagnostic tools that puts critical, real-time information about each and every truck you own right on your computer.



+ training

Studies have shown that effective operator training can help you improve your bottom line. Designed to help you protect your people, equipment and materials, Safety on the Move® can assist you in reducing incidents, equipment downtime and product damage, and increase operator productivity.



WE'VE GOT YOU COVERED

Raymond provides world-class support tailored to meet your needs for fleet management and optimization, consistent maintenance and service—backed by our response-time guarantees, technician and operator training, and more. Our network of more than 100 Sales and Service Centers provides comprehensive packages of customized solutions, designed to help you drive down costs and run your business better and smarter.

- + Flexible financing solutions
- + Lower ownership interest rates
- + A variety of rental and leasing options
- + Certified, pre-owned lift trucks
- + Strong warranties
- + Raymond Asset Protection™ — three levels (Scheduled, Comprehensive, Optimal)

AA
23

23

AA
21



RUN BETTER. MANAGE SMARTER.

At Raymond, our aim is to deliver the utmost quality and to work for continuous improvement every day, in every aspect of our business. We are proud of what we build. We are proud of the level of service we provide to keep our customers' business up and running. We take pride in our commitment to our customers through our end-to-end approach in helping them find smarter, more efficient, and more effective solutions.

We value the trust that Raymond has earned through decades of proven performance and hands-on innovation. Since the patenting of the first hand-pallet truck to the invention of the reach truck to our pioneering work in narrow aisle operations and beyond, Raymond has led the way in providing customers with the tools and expertise to improve their business.

IF YOU'RE LOOKING FOR A PARTNER WITH THE TOOLS AND EXPERIENCE TO HELP YOU RUN BETTER AND MANAGE SMARTER, LET'S TALK.

PO Box 130
Greene, New York 13778-0130

Toll free 1-800-235-7200
Fax 1-607-656-9005

www.raymondcorp.com

Due to continuous product improvements, specifications are subject to change without notice. Some systems and features shown are optional at extra cost. IWAREHOUSE, Raymond Asset Protection, iTRACK, Raymond Parts, Raymond RENEWED, Safety on the Move, ACR System, Raymond, Swing-Reach, Reach-Fork, Transtacker, intellispeed and intelliguide are U.S. trademarks of The Raymond Corporation.

©2015 The Raymond Corporation
Printed in USA
SIPB-1042 0315 XX-XX

RAYMOND